

A Multiple Handover Method by Using the Guide of Mobile Node

Radhwan Mohamed Abdullah

Divison of Basic Sciences, College of Agriculture and Forestry, University of Mosul, Mosul, Iraq.
E-mail: radwanmas@uomosul.edu.iq

Radhwan Basher

Department of Computer Science, College of Computer Science and Mathmaticaly, University of Mosul, Mosul, Iraq. E-mail: radwanbasher@uomosul.edu.iq

Ayad Hussain Abdulqader

Department of Computer Science, College of Computer Science and Mathmaticaly, University of Mosul, Mosul, Iraq. E-mail: ayad_alezzi@uomosul.edu.iq

Received August 04, 2020; Accepted October 10, 2020

ISSN: 1735-188X

DOI: 10.14704/WEB/V17I2/WEB17070

Abstract

Today's healthcare system can be characterised using the up-and-coming integral component of mobility management of wireless body area networks (WBANs). In general, remote sensor nodes of WBAN are positioned on the body of a subject. Meanwhile, recommendations for specific proxy mobile IPv6 (PMIP) approaches have emerged, but its comparatively unfeasible nature in terms of group mobility management with regards to WBAN. Therefore, it shows a likelihood for expansive registration and handover interruptions. Thus, this work offered an alternative aimed at curbing such restrictions via an enhanced group mobility management method. The approach underlined the integration of authentication, authorisation, and accounting (AAA) services into the local mobility anchor (LMA) as another option for independent practice. Moreover, the proxy binding update (PBU) and AAA inquiry messages were consolidated, whereas the AAA response and proxy binding acknowledge (PBA) message were amalgamated. The resulting outcomes depicted the proposed method's superior performance in comparison with the current PMIP approaches in the context of registration delay time, handover interruption, and average signalling cost.

Keywords

Mobility Management, Wireless Sensor Network, Handover Operation.

Introduction

A major challenge observed throughout the world population growth is the issue of expanding aging population due to elevated life expectancy. By 2025, the global aging population (aged > 65) is projected to display a two-fold rise from 357 million to 761 million [1]. Consequently, such growth has directly resulted in increased healthcare expenses, thereby prompting the breakthrough of innovative technology-based developments for existing healthcare tools, such as small and intelligent medical sensors. Here, these medical remote sensors are affixed on the body or beneath the subject's skin in which information gleaned will be transmitted to an exterior medical server. Accordingly, these sensors enable better physical mobility.

Furthermore, the mortality rates due to serious medical conditions such as cancer and cardiovascular disease have been increasing per annum, which is primarily a result of many being diagnosed with the disease when it is too late. In view of this, early detection of a particular disease may be achievable through the application of cutting-edge technological developments in WBAN systems, thus aiding towards their respective early preventive measures. "Fundamentally, the sensor nodes on WBAN can be utilised for a progressive monitoring process of one's health status" [2-4]. "In WBAN, these sensors can be affixed to the human body or outfits" [5, 6]. Henceforth, they function to analyse the determinants of the health status, which are subsequently collected and imparted to the central server for further healthcare implementations.

In solving the issue of Internet Protocol (IP) shortage, a solution underlined is the creation IPv6 addresses as they contain wider spaces for such addresses. Recently, an increasing amount of interest has been noted in terms of low-power wireless personal area networks (LoWPANs) due to the utilisation of Internet of Things (IoTs). Besides, a working group of the Late for IPV6 over (6LoWPANs) has been initiated by the Internet Engineering Task Force (IETF) [7], thereby rendering the remote sensor nodes to be possibly linked to the IPv6 networks. However, these nodes lack the capacity and ability to enhance and shore up the whole IPv6 address due to the ultimate packet size of IEEE 802.15.4, which is merely 127 bytes. Therefore, enabling the 40-byte IPv6 packet header compacted into 2 bytes for inbound communication is achieved by the addition of an adaptation layer by the 6LoWPAN between the network layer and MAC. Concomitantly, the 6LoWPAN decompresses the layer for the outbound interface.

Similarly to the handover control, the mobile settings require the sensor nodes to be employed for mobility management. Accordingly, some host-based methods are deemed

unsuitable for the application of IP-based sensor in WBANs [8- 10]. While containing the mobility stack, each of the sensors are subjected to active involvement in creating mobility-related signalling. Following this, one of the solutions possibly adapted for the mobility management in 6LoWPAN-based WBAN may be the network-based approaches, which include PMIP. In line with this, above, suggestions are rife regarding several methods' possible utilisation for supporting the mobility with regards to the 6LoWPAN-based WBAN [11, 12], as the latter uses the PMIP protocol [13]. As such, registration and handover interruptions can be reduced via such methods, while the delay performance may be improved concomitantly.

Therefore, this paper proposes the use of an enhanced group mobility management method, which is designed for WBAN and undertaken by implementing a new approach for the PMIP. The proposed solution is believed to be capable of leading to a significant reduction of the delay time for registration. Besides, it allows a decreased handover delay and, most importantly, minimises the average cost of the handover signalling. Following this, the suggested method in this study includes the authentication features, which are integrated into local mobility anchor (LMA) as another option of independent practice. Meanwhile, the proxy binding update (PBU) message and authentication, authorisation, and accounting (AAA) query message are combined, while the AAA reply and proxy binding acknowledge (PBA) message are also amalgamated.

The main contributions of this paper are as follows:

1. It highlights the issue of group mobility management in WBANs, thereby discussing the management of registration and handover interruptions in the network and demonstrating the need for a new solution.
2. A thorough survey is performed across a majority of notable related works in the area of group mobility management in WBANs. It encompasses previous methodologies, which are addressed accordingly, and further issues pertaining to network management in WBANs are discussed in detail. The review will comb through and outline the strengths and shortcomings of each methodology.
3. An enhanced group mobility management method in the context of WBANs is introduced, whereby the proposed solution focuses on resolving the issue of registration and handover during nodes deployment.
4. A new mobility management scheme has been proposed, which is aimed at enhancing the management of node movements in WBANs. It involves several processes that provide LMA as another option for independent practice.
5. The efficiency and the effectiveness of the proposed strategy is evaluated by using a variety of experiments and utilising the network simulation. These experiments will

demonstrate the superiority of the proposed scheme in the context of registration and handover delays, as well as the average signalling cost.

The rest of this work is presented in the following manner: first, a short overview of related works is detailed in Section 2, followed by a description of the enhanced group mobility management method proposed in Section 3. Next, Section 4 illustrates the simulation environment and presents the numerical results of the experiments, while the performance analysis is highlighted in Section 5. The content will draw a comparison between the proposed and existing methods via numerical analysis accurately. Finally, the conclusions are presented in the last section, namely Section 6.

Related Work

“Sensor devices plus protocols are subjected to a survey to determine the physical layer, data link layer, and radio technology features of body area networks” [14]. Various and intensive research efforts have been made, which focus on security issues in WBAN [15-17]. The work presented by He et al. [15] has proposed a new method to tackle the issue of an attack-resistant and lightweight trust management, namely ReTrust, which consists of two-tiered architectures. These architectures tend to implement the Collection Tree Protocol. The experimental outcomes of ReTrust have indicated that beyond its capacity to identify malicious or faulty behaviours, it can also enhance the network performance.

Furthermore, another proposed model is the distributed trust evaluation model, which offers the use of straightforward cryptographic techniques and medical sensor networks (MSNs) [16]. It relies on monitoring the relevant node behaviours in which such element incorporates the transmission rate and leaving time, which are used to distinguish the malicious nodes. In the work of Zhang et al. [17], a key agreement method has been introduced as the means of generating a common key employing the electrocardiogram (ECG) signals. Such key is shared with the neighbouring nodes in BANs.

Based on existing evidence, the propriety of 6LoWPANs can be emphasised for the sensors in WBANs as such sensors meet the requirements of the IEEE 802.15.4 standard [18]. Accordingly, it is safe to argue that their mobility is one particularly promising approach for the sensors in WBANs. Conversely, the current IPv6 host mobility protocols are deemed not appropriate for 6LoWPAN-based remote sensors due to them being tunnel approaches. Accordingly, all mobile sensors are thus engaged in the mobility-related signalling in the bid to ensure constant communication [8-10, 19].

In the work of Oliveira et al. [20], the requirements and resources are some challenges requiring solution with respect to adjusting the existing solutions in order to meet the 6LoWPAN requirements. Therefore, more investigations must be done on 6LoWPAN mobility. Accordingly, a method proposed by Islam et al. [21] poses its intention to enhance the IP-WSN, which is intended to make use of a new communication packet format in the ingress interface towards addressing the handoff procedure. Although Oliveira et al. [20] have suggested that it is not possible to utilise multi-hop communications in the PMIPv6 protocol, Haw et al. [22] have stated their use is possible in the ingress interface. Here, the multi-hop communication method may be utilised via the employment of mesh routing for the sake of expanding the range coverage.

Regardless, the focus of this proposed method in [22] is one single mobile node, thereby rendering it inappropriate in yielding an effective solution when more than one node is circulating around. In contrast, Bag et al. [23] have highlighted a 6LoWPAN mobility-supported method, which relies on the types of 6LoWPAN dispatched. However, one of its pitfalls is the lack of any plain improvement to decrease the handoff delay.

Moreover, it is clear that the network-based approaches may be appropriate for supporting the mobility management of 6LoWPAN-based body sensors [13, 24]. Here, the network node acts in place of the sensors, thus having the ability to share the mobility-related signalling and exclude the duplicate address detection (DAD) of the IP address. Following this, the cost of the control signalling and each sensor's late handover can be reduced. Additionally, from the perspective of network-based approaches, the network mobility (NEMO) [11] is recommended by a previous study [26] with respect to the 6LoWPAN-based mobility method. Henceforth, the handover is carried out by a mobile router with the intention of modifying the 6LoWPAN dispatch. However, the mobile router may be overloaded by this particular type of protocol, rendering it crucial for the concomitant sessions and decreased handover interruptions. The same holds true regarding the signalling rate of group-based mobility in 6LoWPAN-based sensor in WBANs. A study undertaken has proposed the presence of countless interrelated sensor nodes that move together and perform handover simultaneously in the PMIPv6 environment [27].

The value of the signal-to noise ratio (SNR) for each sensor is calculated by the LMA, which concurrently creates a group of sensors with the same SNR values. Furthermore, said protocol decreases the cost of the handover signalling by sending the PBA per each group, thereby allowing several extra and unwanted handover messages to be saved, such as PBU and de-registration (DeReg). Regardless, this protocol lacks the capability to decrease the messages of both router solicitation (RS) and router advertisement (RA) due

to the collective body sensor movements in the PMIPv6 domain. Hence, one may safely conclude that the protocol is not suitable for the 6LoWPAN-based sensor in WBAN.

Enhanced Group Mobility Management Method

This section explains the details of components making up the improved group mobility management method proposed for the WBAN roaming in the PMIPv6. It aims at reducing the registration delay, handover delay, and average handover signalling cost. The method consists of three components, namely: network model, initial registration, and handover operations, which will be explained in the following subsections accordingly.

1) Network Model

Figure (1) illustrates the network model for the proposed method. Here, a group of 6LoWPAN sensors is deployed on to a human body, whereby one of the sensors functions as the coordinator. It has the ability to interchange with the control signalling messages in the PMD and acts on the behalf of other sensors. Furthermore, it is particularly noteworthy that the 6LoWPAN domain incorporates a PMD. In the proposed method, the LMA carries out the AAA function in which it should be noted that the handover operation is implemented between two adjacent MAGs and does not require assistance from any AAA server for the specific group of sensors. Moreover, both the authentication processes and that of the sensors group are maintained by the LMA. Besides, each MAG is shown to lack the ability of carrying out the AAA operation with the AAA server due to the LMA having the AAA functionality. In actuality, the pMAG domain is characterised by the coordinator sensor communicating with the correspondent node (CN) and then moving to an nMAG via the handover.

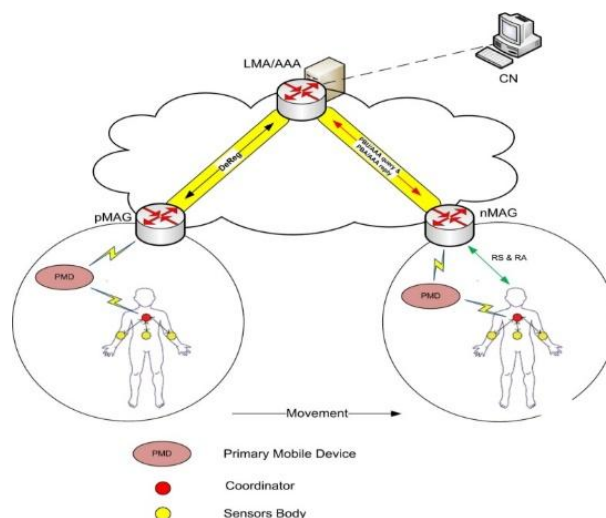

Figure 1 The proposed method

2) Initial Registration

The stage of registration aims at reducing the volume of control messages volume and the initial registration of the suggested method is duly illustrated in Figure 2. As soon as a group of body sensors enters the PMIP coverage area, a grouped RS message containing the data on group link-layer addresses (LLAs) and MN-IDs is sent to the MAG by the coordinator, which is located at the nearest MAG. After receiving the RS message, the MAG will shoot out an aggregated PBU and AAA query message to the LMA/AAA. However, one should note that these features are dissimilar to the previous group mobility management methods. Here, the proposed method is a combination of these two messages, thereby leading to a significant reduction in the average cost of handover signalling and delay registration cost.

Following the PBU/AAA query message, the LMA/AAA will send a PBA/AAA reply message, after which the MAG commences the DHCP solicitation method in order to demand home network prefixes (HNPs) for each body sensors consecutively. Then, the DHCP server will provide the answers for each body sensor using the respective unique HNPs. Together with making the binding cache entry, the MAG then stores the HNP information. Accordingly, the DHCP server not only designs the respective home-of-address (HoA) from such prefixes, but it also sends the HoA to the MAG. Finally, the MAG reverts a response by sending an RA message to the coordinator.

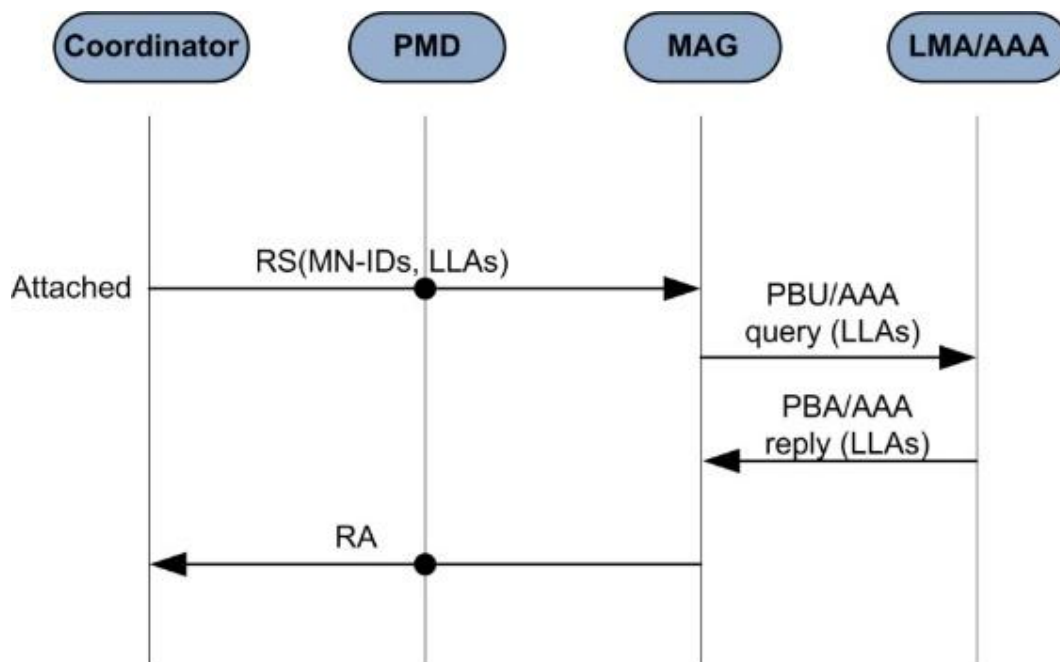

Figure 2 The initial stage

3) Handover Operations

Active scans along with adjacent PDMs are occasionally carried out by the body sensors, which is a process undertaken by sending a beacon request. The beacon request is sent to the adjacent PMDs via the body sensors, whereby they stimulate the beacon message having their MAG-IDs to the sensors. After accepting the beacon message, they will determine whether the sensors remain attached to the same MAG or transferred to a new one. This can be verified through a comparison of the present and former MAG-IDs; intra-PAN mobility is distinguished if the current and previous MAG-IDs are identical. Put differently, if the current MAG-ID can be singled out from the old one, it is proven that the body sensors are capable of detecting the shift from the prior to later MAGs.

Figure 3 depicts the signalling flow of the handover process in detail. Upon the detection of coordinator's detachment from its link by pMAG, the pMAG eliminates the binding and routing state for this particular coordinator and a DeReg message is sent to LMA/AAA in order to close the packets delivery tunnel. Following the request arrival, the LMA/AAA will accept it and wait for an updated binding of the new link by the nMAG. When the coordinator is deployed on the nMAG, an aggregated RS message is sent to the nMAG, whereby the resulting aggregated PBU/AAA query and PBA/AAA reply messages will be with LMA/AAA by the nMAG. After the completion of this operation, the nMAG sends a response to the coordinator, which contains a router advertisement (RA) message. As soon as the CN receives the PBU message sent by nMAG, the route is optimised and its mapping table is updated, before it sends a PBA to nMAG. As a result, both nMAG and CN will now be able to use the optimised route.

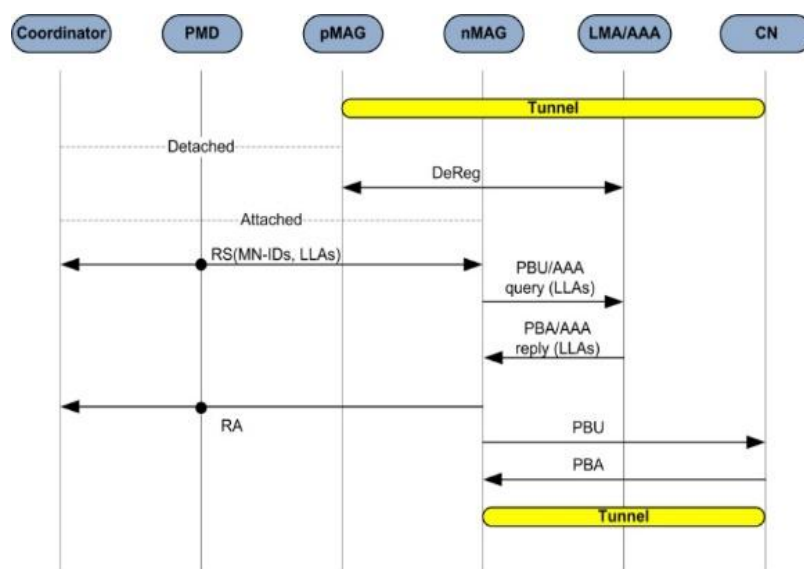

Figure 3 The signaling flow

Simulation Environment and Numerical Results

Figure 2 illustrates the proposed network scenario, which incorporates three WiMAX, five WLAN networks, and 20 MNs. In particular, the WiMAX and WLAN cells' radius is 2,000m and 150m, respectively, whereas the MNs have a speed range of either 5, 10, 15, 20 or 25 m/s in random paths. Table 1 displays a brief account of the parameter variables employed by default in the simulations, thereby showing the network topology implemented. In this paper, the simulation method utilised is tested to determine the different speeds possessed by four respective scenarios of traffic type in MNs. In general, these MNs possess various packet volumes and every scenario is an example of an individual traffic class. For example, Video, Best Effort, and Video and Background classes are incorporated in the individual traffic class. The values of these network characteristics are a representation of the traffic classes in accordance with the recommendations of the European Telecommunications Standards Institute (ETSI) [18] as the Quality of service (QoS) requirements.

Every class is employed as a reflection of the multitude of altitudes for the priority-based ratio. As such, they will yield various levels of priority for the candidate networks and the subsequent simulation can be operated via four scenarios and two modes of priority distribution, simply for the sake of collecting the necessary statistics. Henceforth, Technique for Order of Preference by Similarity to Ideal Solution (TOPSIS) is employed to select the network preferences. Therefore, a discussion is presented in order to highlight the manner in which the priority criteria are allocated for each scenario and the related conditions may potentially influence the ultimate performance metrics and outputs. Furthermore, this section explains and discusses the numerical results obtained due to the proposed solution for group mobility management in WBANs.

An evaluation of the effectiveness and performance of the proposed method is undertaken by developing a simulation by using the National Institute of Standards and Technology (NIST) mobility package [28]. The incorporated package is specifically built for the NS2 network simulator version 2.29 with PMIP [8-10]. Accordingly, three recent methods are implemented as the benchmark for comparative purposes against the work's proposed method. The methods incorporated include the PMIP method [13], thereby denoted as method 1 in the experimental results, while the second method is the PMIP Group method [11] and thereby referred to as method 2. Meanwhile, the third method of PMIP coordinator method [12] is henceforth named as method 3 in the experiment results.

For the purpose of crystal-clear analysis of the initial registration and handover operations, this paper reports the experimental results of all three methods accordingly. Meanwhile, the proposed method is employed in assessing its performance, specifically in the context of the registration delay, handover delay, and average signalling cost. Thus, the default value of every parameter incorporated is designated per the following [29]:

$$H_{\text{MAG-LMA}} = H_{\text{MAG-LAM/AAA}} = 5, H_{\text{MAG-AAA}} = H_{\text{LMAAAA}} = 5, L_{\text{wl}} = 10\text{ms}, L_w = 2\text{ms}, q = 0.5, T_q = 5\text{ms}, N_s = 10, S_c = 96 \text{ bytes}, S_d = 200 \text{ bytes}, B_{\text{wl}} = 11\text{Mbps}, \text{ and } B_w = 100\text{Mbps}.$$

The findings subsequently revealed that L_{wl} , T_q , and N_s were reliant upon network circumstances. Henceforth, the candidate methods and their respective performance were compared by changing the values of specific parameters.

1) Registration Delay

Figure 4 demonstrates the effect of link delay in wireless networks (L_{wl}) on the registration delay. First, all candidate methods yielded outcomes indicative of a positive correlation between the registration delay and L_{wl} value. Therefore, the suggested method obtained superior performance compared to other methods, which was attributable to its usage of the AAA functionality over LMA, thereby not requiring AAA query and reply operations between the AAA and LMA. As the suggested method underlined, the MAG amalgamated the aggregated proxy binding and authentication operations together.

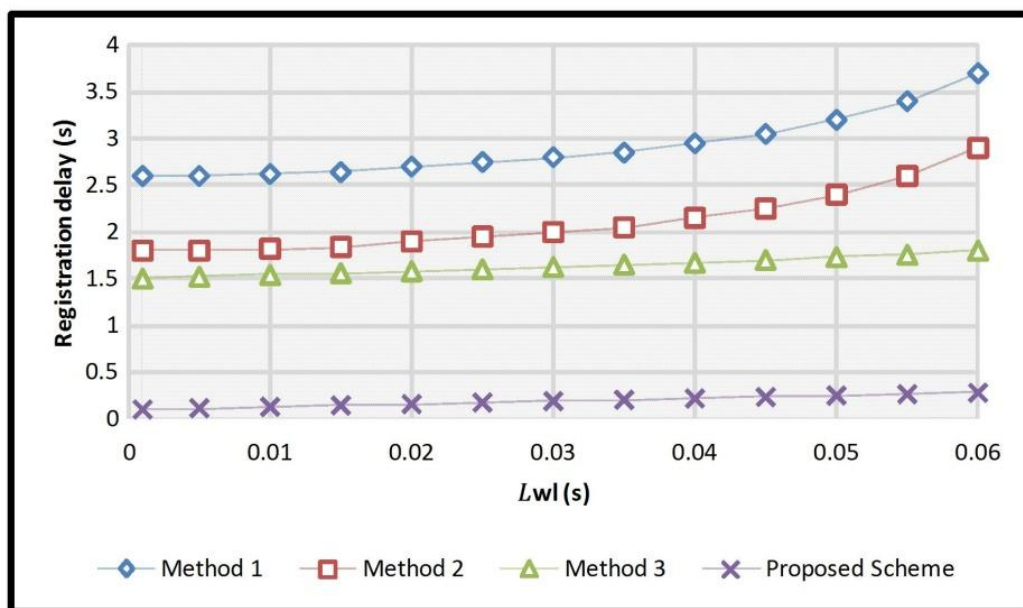

Figure 4 Impact of Wireless link delay on registration delay

In Figure 5, the effect of varying queuing delays (Tq) at each node is demonstrated on the registration delay. Accordingly, a positive correlation was observed between the registration interruption and Tq value for all candidate methods. Hence, the suggested method had superior performance compared to other candidate methods, thereby attributable to the implementation of the AAA functionality by each LMA.

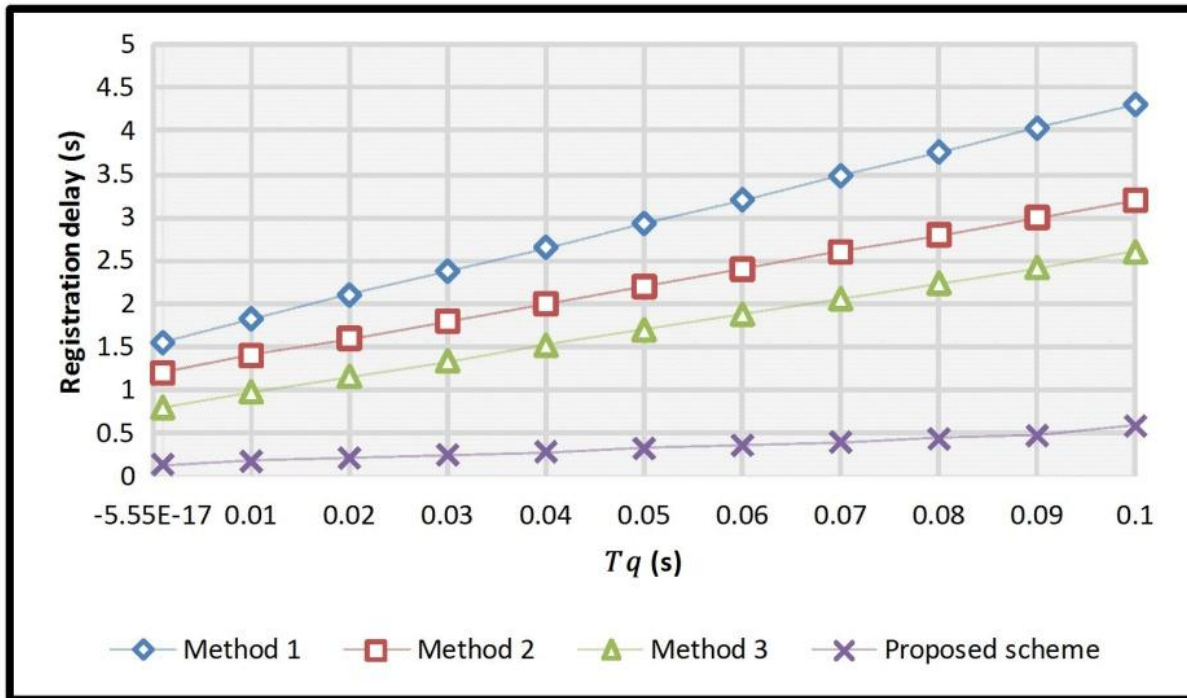

Figure 5 Impact of queuing delays on the registration delay

Next, Figure 6 displays the effect of sensor quantity (Ns) on registration interruption, whereby a positive relationship is observed between the handover interruption and the Ns for the remaining methods according to the results obtained. Furthermore, the proposed method was unaffected by the Ns , which was primarily due to the volume of authentication messages present for each registration regardless of the body sensor quantity. Besides, it implemented the AAA functionality over LMA, rendering the operation between LMA and MAG unnecessary in order to send/receive the PBU/PBA as a result of their tendency to merge within the authentication messages. Consequently, each body sensor requires a lesser amount of control messages to be conveyed, thus resulting in less registration interruptions alongside the incremental amount of body sensors.

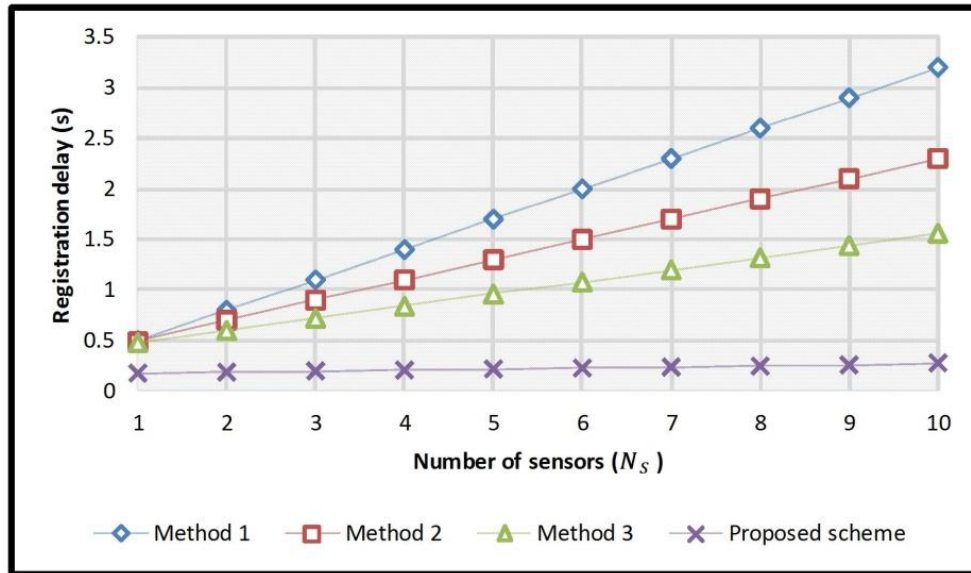

Figure 6 Impact of sensor quantity on registration delay

2) Handover Delay

Figure 7 demonstrates the effect of link delay in wireless networks (L_{wl}) on handover delay, whereby a positive correlation is observed across all candidate methods. Therefore, this confirmed the proposed method's superior performance compared to existing methods, which could be attributed to the AAA function. Such function was performed by the LMA, whereas the handover procedure was conducted between two adjacent MAGs in the absence of the AAA's aid.

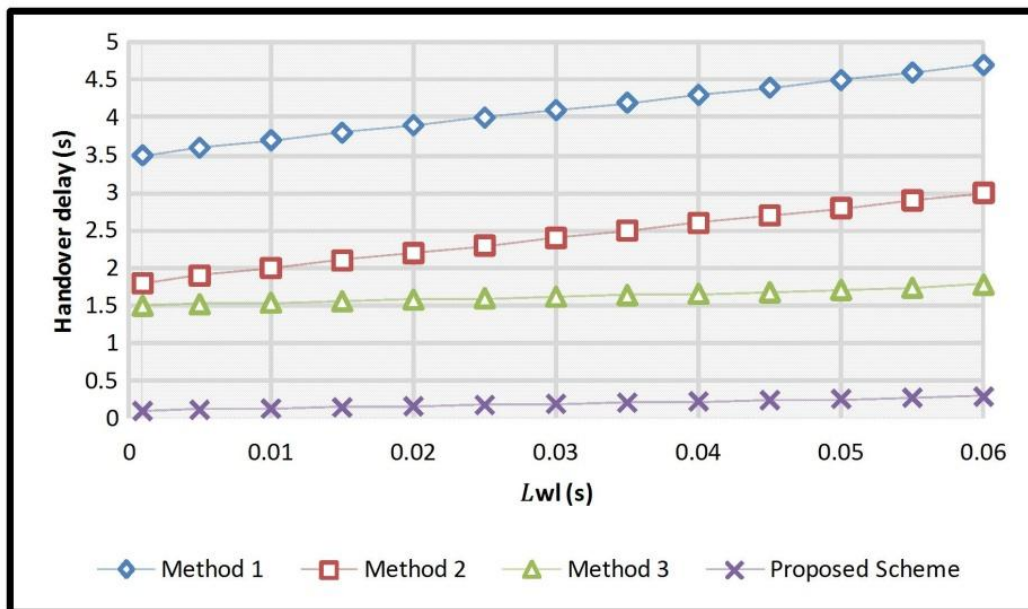

Figure 7 Impact of Wireless link delay on handover delay

In Figure 8, the effect of queuing delay (Tq) at every node on the handover delay is duly noted. Accordingly, the results revealed the positive correlation between the handover interruption and Tq for the collective candidate methods, further depicting the proposed method's better performance compared to others.

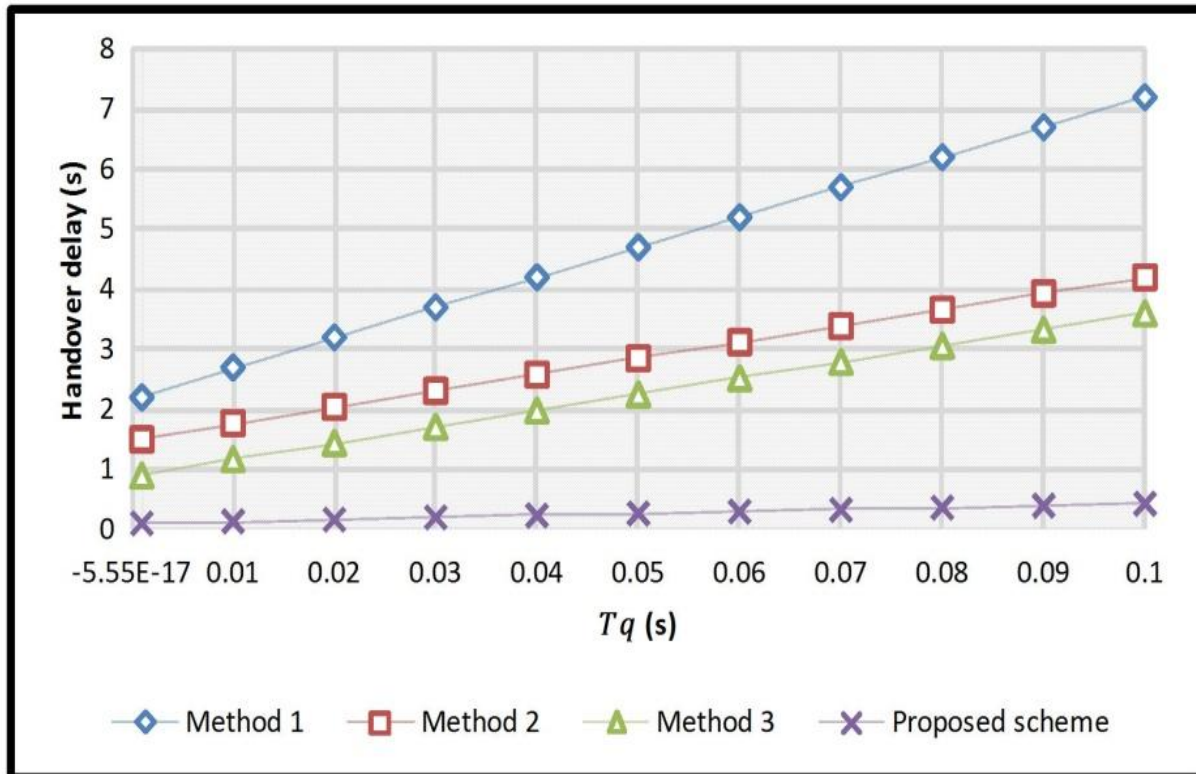

Figure 8 Impact of queuing delays on handover delay

Figure 9 displays the effect of sensor quantity (Ns) on handover delay, whereby a positive correlation is found between the handover interruption and Ns for the remaining methods. Similarly, the proposed method was not influenced by Ns due to every handover having messages for the PBU/AAA query and PBA/AAA reply both. Here, the messages yielded a constant size regardless of the amount of body sensors. The proposed method's intention for AAA functionality execution over LMA notwithstanding, the handover operations were carried out between two adjacent MAGs not requiring the support of AAA, thereby rendering the authentication operations between AAA and LMA unnecessary. As a result, each body sensor was tasked with fewer quantity of control messages requiring transformation, yielding less handover interruption as the amount of body sensors rose.

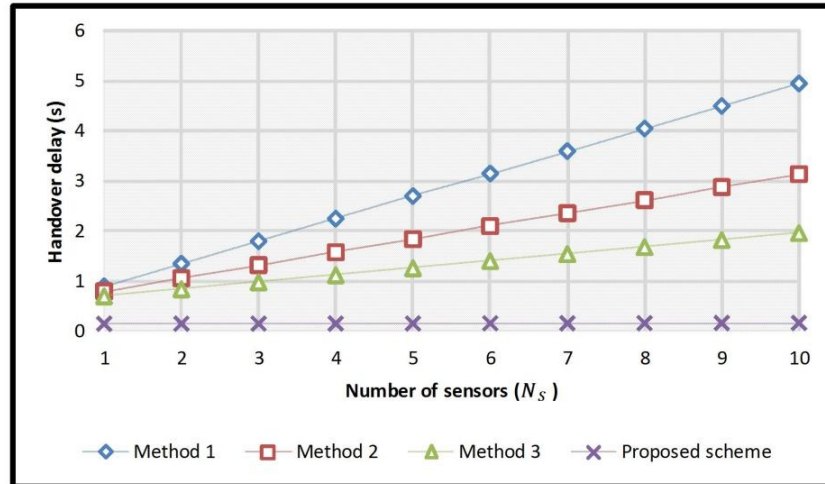

Figure 9 Impact of sensor quantity on handover delay

3) Average Signalling Cost

Figure 10 illustrates the experimental results obtained in investigating the effect of the amount of sensors (N_s) on the average signalling cost of handover. According to the outcomes, the number of control messages constantly exchanged over the network model. Furthermore, the figure revealed the proposed method consistently having the lowest average signalling cost compared to the remaining three methods tested. Such outcome could be explained by the method's specific usage of a message to carry the information of other sensor nodes, which would in turn minimise the control message. Moreover, the proposed method was noted to be uninfluenced by the number of sensors (N_s) in which such enhancement was due to its consistent total signalling cost despite the increasing amount of body sensors. This phenomenon could be explained by the constant amount of PBU/AAA query and PBA/AAA reply messages for each handover in spite of the amount of body sensors being considered.

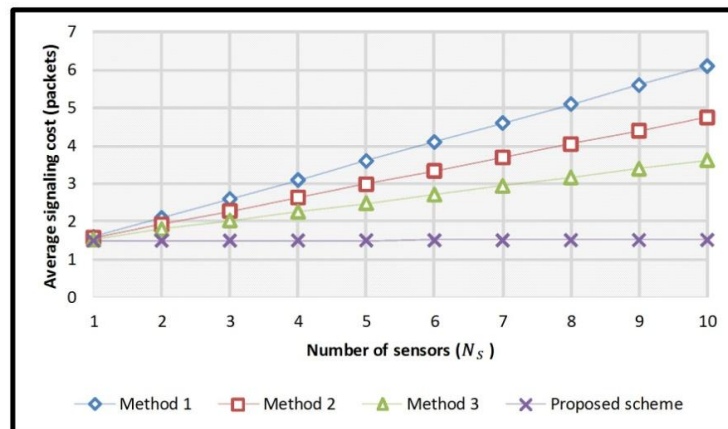

Figure 10 Impact of sensor quantity on average signaling cost

Performance Analysis

In this section, the performance evaluation and analysis of the enhanced group mobility management method are detailed accordingly. First, the analysis emphasised the comparison between the proposed solution versus the recent methods in the context of the handover registration, handover delay, and average signalling cost of the handover. This was due to their respective role as the critical performance metrics considered in measuring the mobile handover method performance according to many prior research works [6, 12, 30-31]. Henceforth, four candidate mobility methods were considered in the analysis, namely: Method 1 [13], Method 2 [11], Method 3 [12], and the proposed method. Further details regarding the analysis will be presented in the following subsections.

1) Analysis Model

Figure 11 illustrates a network recommended for such process in which the parameters of bandwidth, latency, and average queuing delay are implemented to represent each wired/wireless link. Furthermore, a generic model was assumed in detailing the multiple access control (MAC) method in which the method underlined the analysis on the registration and handover interruptions with regards to the mobility method proposed. Table 1 summarises the notations and parameters used for the analysis.

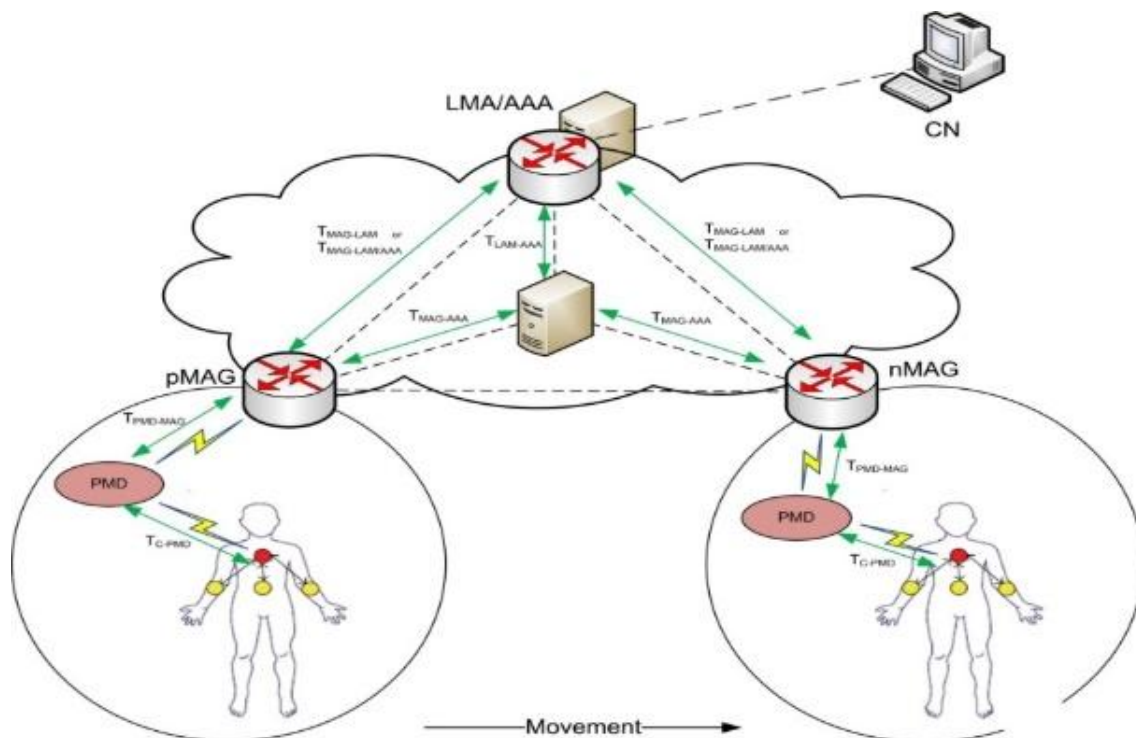

Figure 11 The analysis of performance

According to Figure 11, $T_{x-y}(S)$ is denoted as the transmission interruption of a message with size S sent from x to y through the "wireless" link; here, every message is capable of enduring the failure at the probability of q via "iid" error model. Therefore, $T_{x-y}(S)$ is denoted as $T_{x-y}(S) = [1/(1-q)] \times [(S/B_{wl}) + L_{wl}]$. Meanwhile, $T_{x-y}(S, H_{x-y})$ is symbolised as the transmission interruption of a message with size S sent from x to y through the "wired" link; here, H_{x-y} refers to the amount of wired hops between node x and node y . Therefore, $T_{x-y}(S, H_{x-y})$ is denoted as $T_{x-y}(S, H_{x-y}) = H_{x-y} \times [(S/B_w) + L_w + T_q]$.

Table 1 Notation

Field	Description
Sc	The size of control packets (bytes)
Sd	The size of data packets (bytes)
NS	The number of sensors in the coverage area
Bw	Wired network bandwidth (Mbps)
Bwl	Wireless network bandwidth (Mbps)
Lw	Wired network delay (ms)
Lwl	Wireless network delay (ms)
$Ha-b$	Average number of hop between nodes a and b
q	Failure probability in Wireless networks
Tq	Queuing delay at each node

2) Registration Delay (RD)

Reference [13] has shown that the body sensors are affixed to the MAG, which allows the coordinator and PMD to send RS messages to it. Initially, the MAG undertakes the AAA process for authentication purposes to all body sensors, before conducting the PBU process by using the LMA and targeting all of the sensors. At this point, the LMA performs the AAA process via the AAA server, which is targeted at all sensors, following which it responds to the MAG by sending the PBA message after the authentication is completed. Then, the MAG will immediately yield a feedback to the entirety of body sensors by sending the RA messages. Consequently, the RD of Method 1 is obtained as follows:

$$RD_{Method1} = N_S \times \{2T_{C-PMD}(S_c) + 2T_{PMD-MAG}(S_c) + 2T_{MAG-AAA}(S_c) + 2T_{MAG-LMA}(S_c) + 2T_{LMA-AAA}(S_c)\}. \quad (1)$$

Per reference [11], the operations of Method 2 employs the aggregated PBU and PBA messages between the MAGs and LMA. Hence, the RD of Method 2 is obtained as follows:

$$RD_{Method2} = N_S \times \{2T_{C-PMD}(S_c) + 2T_{PMD-MAG}(S_c) + 2T_{MAG-AAA}(S_c) + 2T_{LMA-AAA}(S_c)\} + 2T_{MAG-LMA}(S_c). \quad (2)$$

Per reference [12], Method 3 implements the aggregated RS and RA messages between the MAG and coordinator, thereby resulting in its RD, which is acquired as follows:

$$RD_{\text{Method3}} = 2T_{\text{C-PMD}}(S_c) + 2T_{\text{PMD-MAG}}(S_c) + 2T_{\text{MAG-LMA}}(S_c) + N_S \times \{2T_{\text{MAG-AAA}}(S_c) + 2T_{\text{LMA-AAA}}(S_c)\}. \quad (3)$$

In the context of the suggested method, the coordinator is affixed to the nMAG and followed by it sending a grouped RS message to the latter via PMD on the behalf of all body sensors. Then, the nMAG exchanges the PBU/AAA query message and PBA/AAA reply message with LMA/AAA, which yields an answer in the form of a grouped RA message to the coordinator accordingly. Therefore, the RD of the suggested method is obtained as follows:

$$RD_{\text{Proposed Method}} = 2T_{\text{C-PMD}}(S_c) + 2T_{\text{PMD-MAG}}(S_c) + 2T_{\text{MAG-LAM/AAA}}(S_c). \quad (4)$$

3) Handover Delay (HD)

The handover delay can be described as the time interval in between the period in which the body sensors are incapable of accepting packets from the pMAG and those in which they are capable of accepting the first packet from the nMAG. According to Reference [13], pMAG sends the DeReg messages to the LMA for the body sensors as soon as the sensors are disconnected from it. Furthermore, upon the linking of the body sensors to the nMAG, the RS messages will be sent there via the coordinator and PMD. After that, the nMAG will undertake the AAA query and answer the processes through the AAA server in order to authenticate the entirety of body sensors. Subsequently, it will further implement the PBU process alongside the LMA for all body sensors, whereby the ensuing AAA query/reply process is then performed by LMA via the AAA server. Following the authentication of such process, LMA sends a reply to the nMAG by dispatching the PBA message. Similarly, the formation of handover tunnel between nMAG and LMA allows the nMAG to send a reply to all body sensors via the use of RA messages. Accordingly, the HD of Method 1 is obtained as follows:

$$HD_{\text{Method1}} = N_S \times \{2T_{\text{C-PMD}}(S_c) + 2T_{\text{PMD-MAG}}(S_c) + 2T_{\text{MAG-AAA}}(S_c) + 4T_{\text{MAG-LMA}}(S_c) + 2T_{\text{LMA-AAA}}(S_c)\} + T_{\text{MAG-LMA}}(S_d). \quad (5)$$

Here, Reference [11] demonstrates the manner in which Method 2 utilises the aggregated DeReg and PBU/PBA messages. Hence, the HD of Method 2 is acquired as follows:

$$HD_{\text{Method2}} = N_S \times \{2T_{\text{C-PMD}}(S_c) + 2T_{\text{PMD-MAG}}(S_c) + 2T_{\text{MAG-AAA}}(S_c) + 2T_{\text{LMA-AAA}}(S_c)\} + 4T_{\text{MAG-LMA}}(S_c) + T_{\text{MAG-LMA}}(S_d). \quad (6)$$

Next, Reference [12] indicates the manner in which Method 3 employs the aggregated RS and RA messages between the MAG and coordinator. Hence, the HD of Method 3 is obtained as follows:

$$HD_{\text{Method3}} = 2T_{\text{C-PMD}}(S_c) + 2T_{\text{PMD-MAG}}(S_c) + 4T_{\text{MAG-LMA}}(S_c) + N_S \times \{2T_{\text{MAG-AAA}}(S_c) + 2T_{\text{LMA-AAA}}(S_c)\} + T_{\text{MAG-LMA}}(S_d). \quad (7)$$

In the context of the suggested method, once the coordinator is attached to nMAG, PMD will be utilised to send a grouped RS message to the latter on the behalf of the body sensors. Then, aggregation will be employed for the nMAG to carry out the AAA operations and proxy binding with the LMA/AAA. Next, the nMAG replies by sending a grouped RA messages to the coordinator. Hence, the HD of the suggested method is obtained as follows:

$$HD_{\text{Proposed Method}} = 2T_{\text{C-PMD}}(S_c) + 2T_{\text{PMD-MAG}}(S_c) + 2T_{\text{MAG-LAM/AAA}}(S_c) + T_{\text{MAG-LAM/AAA}}(S_d). \quad (8)$$

In conclusion, the following formulae are thus obtained accordingly:

$$RD_{\text{Proposed Method}} < RD_{\text{Method3}} < RD_{\text{Method2}} < RD_{\text{Method1}} \quad (9)$$

$$HD_{\text{Proposed Method}} < HD_{\text{Method3}} < HD_{\text{Method2}} < HD_{\text{Method1}} \quad (10)$$

According to the outcomes of the performance analysis, the suggested method was proven to enhance the group mobility management performance in the context of registration delay and handover delay during the handover process. Meanwhile, the total processing time of each of the methods were calculated via various experiments, thereby yielding a value equal to 500ms [6, 12, 29], which was an important representation of the whole algorithmic processing time. Accordingly, the time recorded for message exchange among the fixed nodes (i.e. LMA, MAG, and AAA) was approximately 10ms, while the recorded message processing time was around 1000ms. Meanwhile, the round-trip transmission time between the sensor nodes and other nodes ranged from [50 to 500] ms.

This paper assumed the use of similar parameter settings for the aforementioned experiments conducted and included in this work in evaluating the three methods. Furthermore, the proposed enhanced group mobility management method functioned under the assumption that the total time between the sensor nodes and other nodes was decreased four-fold for the registration delay. While, plus five times for the handover

delay that is happening in the network, which indicated a minimum best-case time of 350ms and maximum worst-case time up to 2500ms. Therefore, the suggested method yielded improved outcomes by 70% when subjected to identical conditions to that of other three methods.

Conclusions

The current study successfully suggested an improved group mobility management method for WBAN in which its AAA function was implemented by the LMA. Therefore, this minimised the amount of control messages. Furthermore, the MAG amalgamated the PBU/AAA query messages for the group of moving sensors in order to further reduce the registration and handover delays both of both between the MAG and the LMA/AAA. Henceforth, the findings obtained underlined the method's superior performance in contrast to the remaining three methods in terms of the registration and handover interruptions and average handover signalling cost. Consequently, the rising pressure on healthcare systems can be alleviated while more support can be leveraged for the ageing population in order to ensure their access to a better life and health care. Additionally, future studies should attempt on emphasising the security issues frequently linked with WBAN.

Acknowledgment

The authors are very grateful to the University of Mosul / College of Agriculture and Forestry for their provided facilities, which helped to improve the quality of this work.

References

- Sun-Min, H., Kyu-Jin, K., Md, M.I., Eui-Nam, H., Weimin, H., Victor, S.F., Andrei, T., Aung, A., Maniyeri, J., & Jit, B. (2010). Multi-modal Sensing Smart Spaces Embedded with WSN Based Image Camera. *Proceedings of PETRA 10, Samos, Greece, ACM New York, USA*, 294-369.
- Dharshini, S., & Subashini, M.M. (2017). An overview on wireless body area networks. *In IEEE Innovations in Power and Advanced Computing Technologies (i-PACT)*, 1-10.
- Cavallari, R., Martelli, F., Rosini, R., Buratti, C., & Verdone, R. (2014). A survey on wireless body area networks: Technologies and design challenges. *IEEE Communications Surveys & Tutorials*, 16(3), 1635-1657.
- Sharma, R., Ryait, H.S., & Gupta, A.K. (2016). Wireless body area network—a review. *Research Cell: An International Journal of Engineering Sciences*, 17, 494-499.
- Sodagari, S., Bozorgchami, B., & Aghvami, H. (2018). Technologies and challenges for cognitive radio enabled medical wireless body area networks. *IEEE Access*, 6, 29567-29586.

- Gohar, M., Choi, J.G., & Koh, S.J. (2015). An ID/locator separation based group mobility management in wireless body area network. *Journal of Sensors*, 1–12.
- Kushalnagar, N., Montenegro, G., & Schumacher, C. (2007). *IPv6 over low-power wireless personal area networks (6LoWPANs): overview, assumptions, problem statement, and goals*. Informational.
- Johnson, D., Perkins, C., & Arkko, J. (2004). *Mobility support in IPv6*. RFC 3775, IETF.
- Yang, X., Wang, L., & Zhang, Z. (2018). Wireless body area networks MAC protocol for energy efficiency and extending lifetime. *IEEE Sensors Letters*, 2(1), 1-4.
- Soliman, H., & Castelluccia, C. (2005). *Hierarchical Mobile IPv6 Mobility Management*. British Royal Flying Corp.
- Arefin, M.T., Ali, M.H., & Haque, A.F. (2017). Wireless body area network: An overview and various applications. *Journal of Computer and Communications*, 5(7), 53-64.
- Chen, Y.S., Hsu, C.S., & Lee, H.K. (2013). An enhanced group mobility protocol for 6LoWPAN-based wireless body area networks. *IEEE Sensors Journal*, 14(3), 797-807.
- Hyeon, S.I., Han, Y.H., Lee, H.B., & Choi, H.Y. (2008). Empirical performance evaluation of IETF mobile IPv6 and proxy mobile IPv6. *In Proceedings of the International Conference on Mobile Technology, Applications, and Systems*, 1-7.
- Shih, Y.Y., Hsiu, P.C., & Pang, A.C. (2018). A Data parasitizing scheme for effective health monitoring in wireless body area networks. *IEEE Transactions on Mobile Computing*, 18(1), 13-27.
- He, D., Chen, C., Chan, S., Bu, J., & Vasilakos, A. (2012). Retrust: Attack resistant and lightweight trust management for medical sensor networks. *IEEE Transactions on Information Technology in Biomedicine*, 16(6), 623-632.
- He, D., Chen, C., Chan, S., Bu, J., & Vasilakos, A. (2012). A distributed trust evaluation model and its application scenarios for medical sensor networks. *IEEE Transactions on Information Technology in Biomedicine*, 16(6), 1164-1175.
- Zhang, Z., Wang, H., Vasilakos, A., & Fang, H. (2012). Cryptography and authentication in body area networks. *IEEE Transactions on Information Technology in Biomedicine*, 16(6), 1070-1078.
- Istepanian, R.S.H., Jovanov, E., & Zhang, Y.T. (2004). Introduction to the special section on m-Health: beyond seamless mobility and global wireless health-care connectivity. *IEEE Transactions on Information Technology in Biomedicine*, 8(4), 405–414.
- Montenegro, G., Kushalnagar, N., Hui, J., & Culler, D. (2007). *Transmission of IPv6 packets over IEEE 802.15.4 networks*. RFC 4944.
- Oliveira, L.M.L., Sousa, A.F., & Rodrigues, J.P.C. (2011). Routing and mobility approaches in IPv6 over LoWPAN mesh networks. *International Journal of Communication Systems*, 24(11), 1445-1466.
- Islam, M.M., & Huh, E.N. (2011). Sensor proxy mobile IPv6 (SPMIPv6) A novel scheme for mobility supported IP-WSNs sensors. *Sensors*, 11(2), 1865-1887.
- Haw, R., Cho, E., Hong, C., & Lee, S. (2012). A 6LoWPAN sensor node mobility scheme based on proxy mobile IPv6. *IEEE Transactions on Mobile Computing*, 11(12), 2060-2072.

- Bag, G., Raza, M.T., Kim, K.H., & Yoo, S.W. (2009). Lowmob: Intra-pan mobility support schemes for 6LoWPAN. *Sensors*, 9(7), 5844-5877.
- Shin, M., Camilo, T., Silva, J., & Kaspar, D. (2007). *Internet-Draft-6lowpan-mobility*. Internet-Draft, 2, 5-10.
- Jinho, K., Rim, H., Eung, J.C., Choong, S.H., & Sungwon, L. (2012). A 6LoWPAN sensor node mobility scheme based on proxy mobile IPv6. *IEEE Transactions on Mobile Computing*, 11(12), 2060-2072.
- Kim, J.H., Hong, C.S., & Shon, T. (2008). A lightweight NEMO protocol to support 6LoWPAN. *ETRI Journal*, 30(5): 685-695.
- Abdullah, R.M., Alwan, A., Salih, K.G., & Zukarnain, ZA. (2019). An enhanced group mobility management method in wireless body area networks. *Journal of Theoretical and Applied Information Technology*, 97(22), 3293-3303.
- Li, Y., Jiang, Y., Su, H., Jin, D., Su, L., & Zeng, L. (2009). A group-based handoff scheme for correlated mobile nodes in proxy mobile IPv6. *In GLOBECOM 2009-2009 IEEE Global Telecommunications Conference*, 1-6.
- NIST Project, Seamless and Secure Mobility, 2009.
- Makaya, C., & Pierre, S. (2008). An analytical framework for performance evaluation of IPv6-based mobility management protocols. *IEEE Transactions on wireless communications*, 7(3), 972-983.
- Radhwan, M.A., Abedallah, Z.A., & Ali, A.A. (2018). Improved Handover Decision Algorithm Using Multiple Criteria. *The 9th International Conference on Emerging Ubiquitous Systems and Pervasive Networks, Procedia Computer Science*, 141, 32–39.