

Cutting-Edge Multiplexer Design With Quantum Dots In Nanotechnology

Mrs Seema Chouhan

Assistant Professor Department of Electronics and Telecommunication Department Institute of Engineering and Technology DAVV, Indore.

Abstract: - Quantum Dot Cellular Automata (QCA) represents a revolutionary leap in nanotechnology, effectively overcoming the inherent limitations of traditional CMOS technology. This advanced nano-technology centers around the precise control of single-electron positions within quantum dots, positioning QCA as one of the most efficient and emerging technologies in the field of nano-electronics architecture. In this paper, we introduce a novel design for a 2:1 multiplexer utilizing QCA, highlighting its significant improvements in efficiency, specifically in terms of area and cell count, over existing multiplexer designs. By harnessing the unique electron dynamics within QCA cells, our proposed multiplexer not only reduces the physical footprint but also enhances overall performance. This study underscores the transformative potential of QCA in the development of next-generation nano-electronic devices, offering a compelling alternative to traditional semiconductor technologies. Our findings indicate that QCA-based designs could play a pivotal role in the future of electronic device architecture, driving advancements in efficiency and miniaturization in the realm of nano-electronics.

Keyword: - Wire, Inverter, Majority Voter, CMOS, VLSI, Quantum dot cellular automata, Multiplexer, Quantum cell.

I. INTRODUCTION

Quantum Cellular Automata (QCA) emerges as a promising technology offering a highly efficient computational platform compared to conventional CMOS technology [1, 2]. QCA, a nano-technological approach, encodes digital information through the polarization of electrons. Its appeal lies in its compact size, accelerated processing speed, remarkable scalability, heightened switching frequency, and notably low power consumption when juxtaposed with CMOS technology [3, 4, 5]. In a QCA cell, comprised of four quantum dots, two electrons are strategically positioned in diametrically opposite dots. This arrangement minimizes Coulomb repulsion, ensuring optimal electron distribution within the cell. Specifically, electrons occupy quantum dots located diagonally across each other to mitigate repulsion effects, thus bolstering QCA's efficacy and energy efficiency in computational endeavors [6, 7].

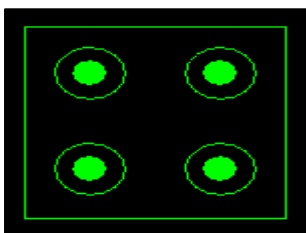
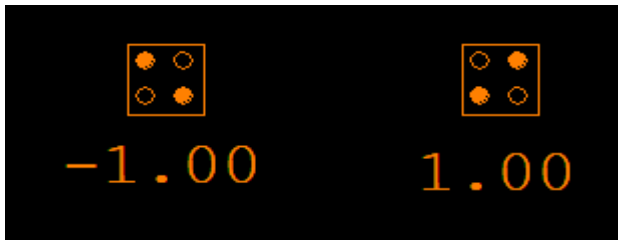

Fig. 1: Empty cell



(a): $P = -1$ (Binary 0), (b) $P = 1$ (Binary 1)

Fig.2: Quantum-dots 90° cells polarizations

In recent years, Quantum Dot Cellular Automata (QCA) has garnered significant attention within the realm of computing [11][12]. At the heart of this emerging paradigm lies the fundamental unit known as a "cell," comprising four metal island dots, referred to as QDs [8, 9]. Positioned at the corners of a square cell, these QDs accommodate two free charges, facilitating the encoding and manipulation of digital information [10].

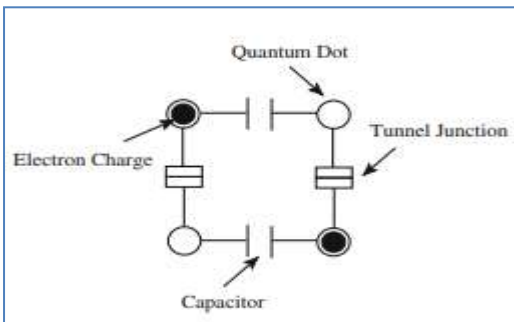

Fig. 3: Basic QCA Cell [10]

II. MULTIPLEXER

A multiplexer (MUX) serves as a combinational logic unit featuring multiple inputs and a single output. It functions by directing one of its inputs to the output line, determined by a control bit word, also known as selection lines. While a multiplexer can accommodate any number of input lines, the configuration of selection lines corresponds to the number of inputs. This relationship between the selection lines and the input lines is mathematically expressed in Equation 1.

$$2^M = N \tag{1}$$

In the equation, M represents the selection lines, while N denotes the number of input lines.

III. QCA Design

Research into binary majority decision elements, driven by advancements in devices like parametrons and Esaki diodes, dates back to as early as 1960. The majority function, also known as the majority voter, is a crucial concept in this domain. It comprises only three input Quantum Dot Cellular Automata (QCA) cells and implements the logic function described by Eq. 2. Here, A , B , and C represent the inputs, while F denotes the single output, as illustrated in Figure 8. In the realm of QCA, the fundamental element is the wire, depicted in Figure 4, while the inverter is represented in Figure 6.

$$F = AB + BC + AC \quad (2)$$

A. QCA Wire Design



Fig. 4: QCA Design for Wire using 12 Quantum Cells as consider 90° (Normal cell) cell

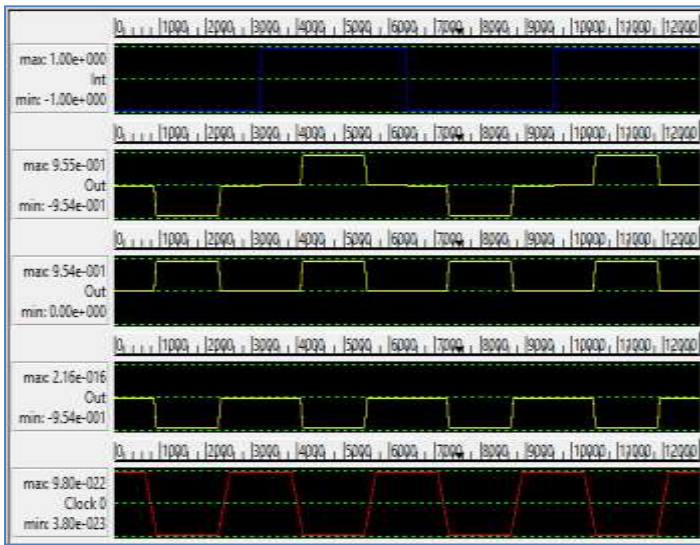

Fig. 5: Simulation result for QCA wire as consider Normal cell for 90°

B. QCA INVERTER DESIGN

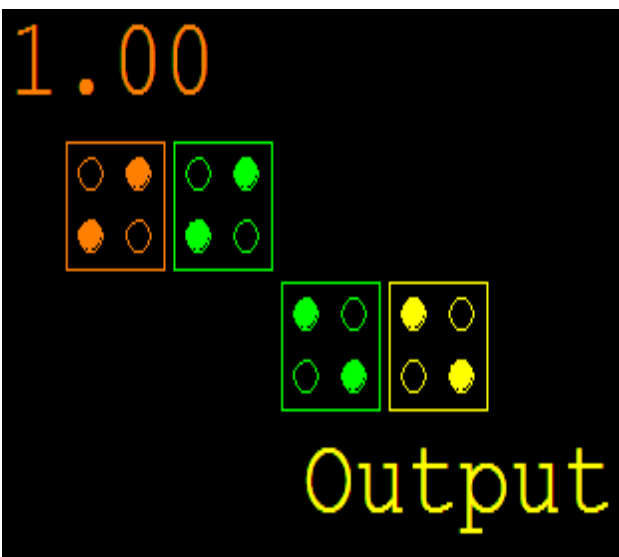

Fig. 6: Layout of an “alternate inverter” configuration

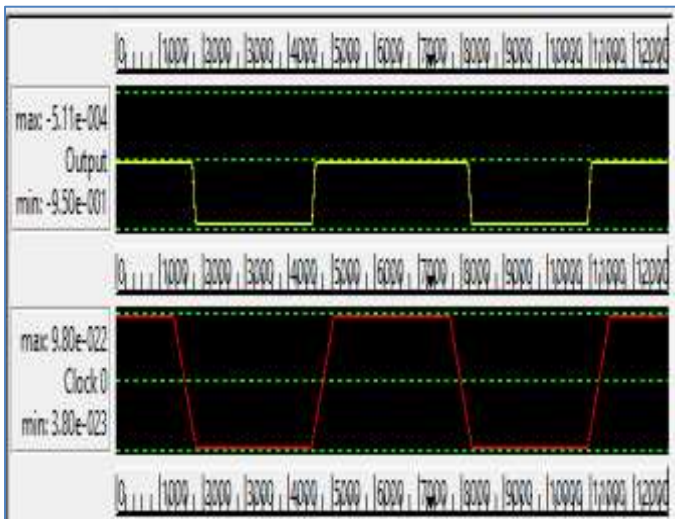

Fig. 7: Simulation result for an “alternate inverter” configuration

C. QCA 3-Input Majority Logic

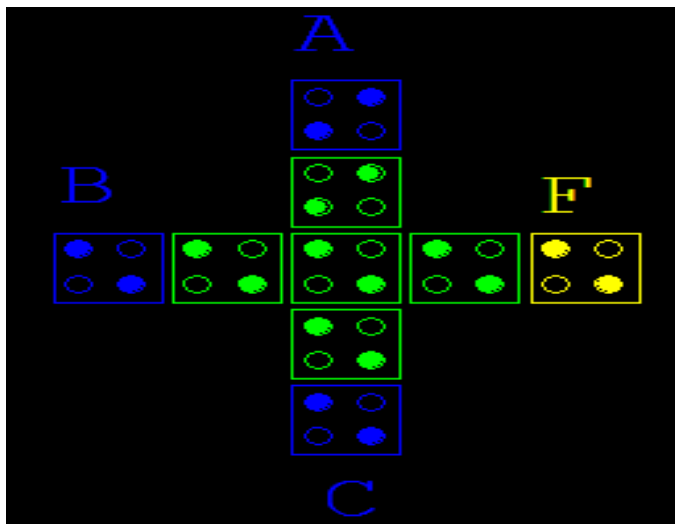

Fig. 8: Layout of majority voter (MV) consist of three input QCA cells

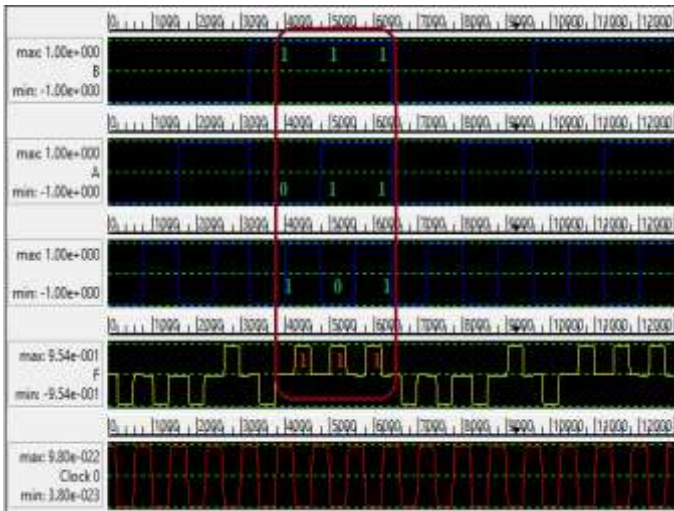

Fig. 9: Simulation result for majority voter (MV) consist of three input QCA cells

VI. Bi-STABLE SIMULATION PARAMETERS

To validate our proposed layout designs of various logic gates, we utilized the latest version of the QCA Designer tool, specifically version 2.0.3. This tool incorporates a bistable simulation engine tailored for Quantum Dot Cellular Automata (QCA) analysis. By employing this specific resolution tool, we were able to accurately simulate the behavior and functionality of the designed logic gates within the QCA framework. This comprehensive approach ensures the reliability and efficiency of our layout designs, providing valuable insights into their performance and suitability for practical implementation in QCA-based systems.

Table 1: Bistable Simulation Parameters

Parameter	Value	
Cell width	18nm	Layer Properties
Cell height	18nm	
QCA-Quantum-dot diameter	5nm	
Default Clock	Clock 0	
Time-step	1.0e-16s	Bistable Approximation (Options)
Relaxation time	1.0e-15s	
Clock-low	3.8e-023J	
Clock-high	9.8e-022J	
Radius of effect	65nm	
Relative permittivity	12.90	
Layer separation	1 1.50nm	

VII. PROPOSED DESIGN

The truth table for the 2-to-1 multiplexer, as depicted in Table 2, illustrates the switching behavior based on the selector (S). When the selector (S) is at 0, the inputs D0 and D1 are directed to the output (Y), where D0 corresponds to the output. Conversely, when the selector (S) is set to 1, input D1 is transmitted to the output (Y),

making D1 the output. Therefore, the Boolean expression for the output (Y) is derived from the truth table as follows:

$$Y = D_0\bar{S} + D_1S \quad (3)$$

Table 2: Truth table for 2:1 MUX

Select	Inputs		Output
S	A	B	Y
0	0	0	0
0	0	1	1
1	1	0	1
1	1	1	1

This is because of its ability to select one signal out of many inputs. We are proposed 2:1 MUX design in figure 10 based on quantum cells shown in figure 10 first proposed design, quantum cells 24, used design area in $0.04 \mu\text{m}^2$.

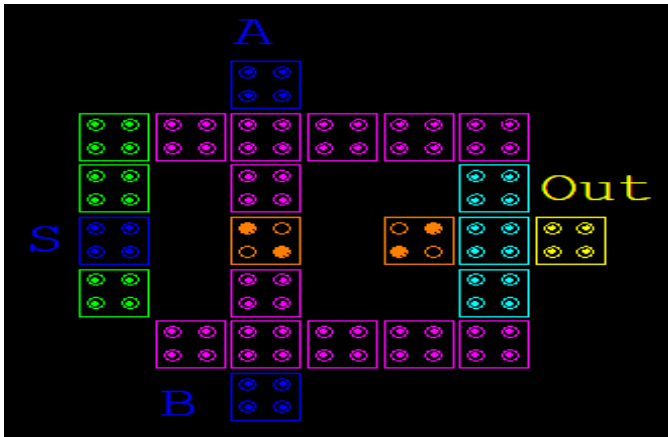

Fig. 10: First proposed 2:1 multiplexer design using 24 Quantum cells

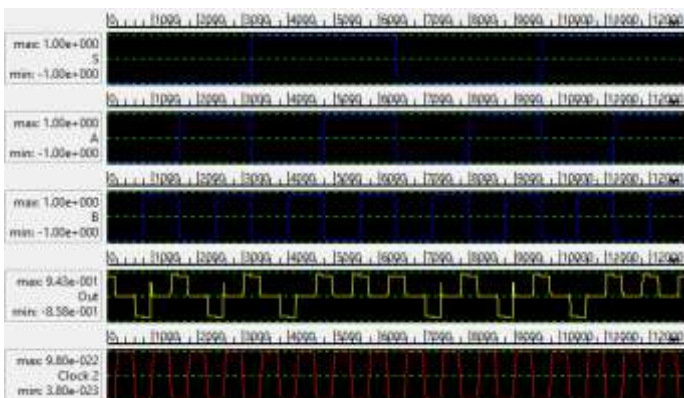

Fig. 11: Simulation Output for 2:1 multiplexer design using 24 Quantum cells

Result Analysis: Selection extents: $(156.19, 150.31) [228.04 \times 162.88] = 37142.55 \text{ nm}^2 = 0.04 \mu\text{m}^2$ Objects selected: 24.

Table 3: The comparative table for the 2:1 QCA multiplexer architectures

Authors Name	Number of Cells	Area	Clock Delay	Wire Crossing
V.A. Mardiris et al. [4]	56	0.07	4	Coplanar
A. Roohi et al. [5]	27	0.03	3	Coplanar
R. S. Nadooshan et al. [7]	26	0.02	3	Coplanar
Proposed Design-1 [Fig. 10]	24	0.03	2	Coplanar

VIII. CONCLUSION

The significance of Multiplexers (MUX) within digital logic circuits and control systems underscores the importance of refining their designs for optimal functionality. This study delved into the novel realm of Quantum Dot Cellular Automata (QCA) to propose enhanced designs for 2:1 MUX. Through a thorough review and validation process utilizing the QCADesigner bistable engine, the proposed circuits demonstrated superior operational efficiency in terms of cell utilization compared to existing designs. This advancement holds promise for the future of nanotechnology-enabled computing, offering potential improvements in speed, scalability, and power consumption. By leveraging Quantum Dots in nanotechnology, these cutting-edge MUX designs pave the way for more efficient and versatile digital systems. As technology continues to evolve, such innovations in QCA-based circuitry contribute to the ongoing progression towards more advanced and reliable computing architectures.

REFERENCES

- [1] Jadav Chandra Dasa & Debashis De , Indian Journal of Pure & Applied Physics Vol. 54, December 2016, pp. 802-811.
- [2] Mrinal Goswami, Brajendra Kumar, Harsh Tibrewal, Subhra Mazumdar, 2014-2nd International Conference on Business and Information Management (ICBIM), 978-1-4799-3264-1114/\$31.00 ©2014 IEEE.
- [3] Hamid Rashidi , Abdalhossein Rezai, Journal Of Nano- And Electronic Physics, Vol. 9 No 1, 01012(7pp) (2017).
- [4] V.A. Mardiris, I.G. Karafyllidis, Int. J. Circ. Theor. Appl. 38(8), 771 (2010).
- [5] A. Roohi, H. Khademolhosseini, S. Sayedsalehi, K. Navi, Int. J. Comput. Sci. Issues 8(6), 55 (2011).
- [6] B. Sen, M. Dutta, D. Saran, B. Sikdar, Lecture Notes Comput. Sci. 7373, 350 (2012).
- [7] R. Sabbaghi-Nadooshan, M. Kianpour, J. Comput. Electr. 13(1), 198 (2013)
- [8] B. Sen, A. Nag, A. De, B.K. Sikdar, J. Comput. Sci. 11, 233 (2015)
- [9] Purkayastha, T., Debashis, D., Chattopadhyay, T., (2016), Ain Shams University, Production and hosting by Elsevier, Ain Shams Engineering Journal.

- [10] Patidar M., Gupta N. (2019), In: Nath V., Mandal J. (eds) Proceeding of the Second International Conference on Microelectronics, Computing & Communication Systems (MCCS 2017). Lecture Notes in Electrical Engineering, vol 476. Springer, Singapor
- [11] Patidar, N., Gupta, N., Amita K., Sumant, Katiyal, S., Choudhary, K.K.,(2013), international journal of nanotechnology and Application (IJNA), 3(2), pp. 1-8.
- [12] Kumar, D., Mitra, D., (2016), Elsevier, Microelectronics Journal 53, pp 90–104.